



MISCELATORE / MIXER Art.F15

FLY/SKY

Descrizione / Description

Miscelatore monocomando da incasso per doccia/vasca con deviatore 3 uscite

Concealed bath/shower mixer with 3 outlets diverter

Caratteristiche Tecniche

Cartuccia a dischi ceramici: Ø35

Tattamento superficiale: cromato







Technical Features

Cartridge ceramic discs: Ø35

Surface treatment: chrome-plated





Finiture leva Lever finishings

| | | | |
|---|---|---|--|
|  | Cromo Chrome |  | Grigio platino Platinum Grey PG1 - RAL 7036 |
|  | Bianco White W1 - RAL 9003 |  | Blu Night blue NB1 - RAL 5026 |
|  | Nero Black B1 - RAL 9004 |  | Verde acqua Water blue WB1 - RAL 5021 |

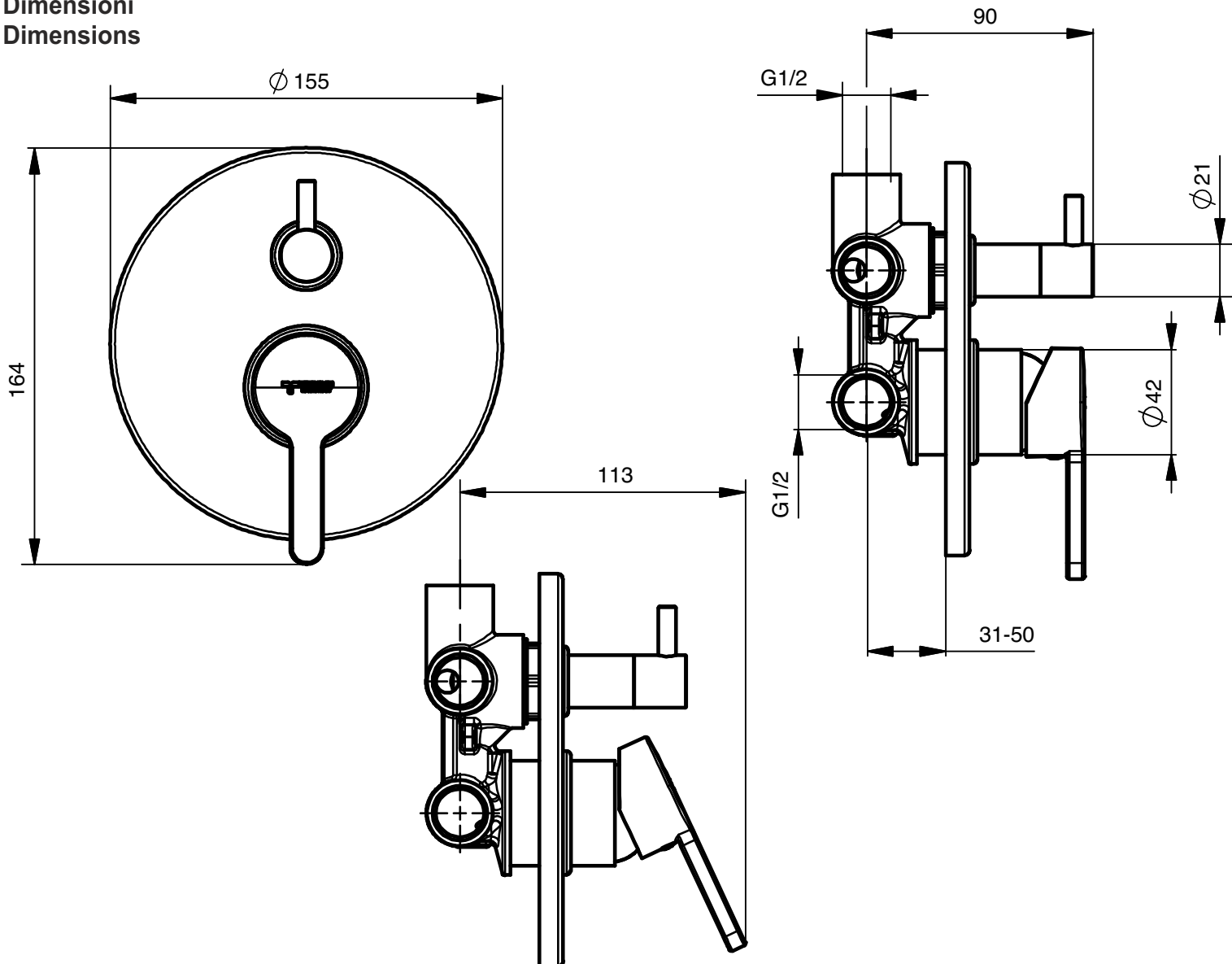
Dimensioni Dimensions





| Modello Model | Codice Code | Codice Prodotto Product Code | Descrizione Description | Finitura Finishing |
|---|----------------|---------------------------------|--|---|
| FLY  | F15 | 411490428 | Miscelatore monocomando da incasso per doccia/ vasca con deviatore 3 uscite | Concealed bath/shower mixer with 3 outlets diverter CROMO |
| FLY  | F15 W1 | 411490438 | Miscelatore monocomando da incasso per doccia/ vasca con deviatore 3 uscite, con leva colorata | Concealed bath/shower mixer with 3 outlets diverter, with colored lever <input type="checkbox"/> RAL 9003 <input type="checkbox"/> RAL 9004 <input checked="" type="checkbox"/> RAL 5026 <input type="checkbox"/> RAL 7036 <input type="checkbox"/> RAL 5021 |
| | F15 B1 | 411490435 | | |
| | F15 NB1 | 411490436 | | |
| | F15 PG1 | 411490437 | | |
| | F15 WB1 | 411490439 | | |



Cromo
Chrome



Bianco
White
W1 - RAL 9003



Nero
Black
B1 - RAL 9004



Blu
Night blue
NB1 - RAL 5026



Grigio platino
Platinum Grey
PG1 - RAL 7036



Verde acqua
Water blue
WB1 - RAL 5021

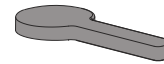
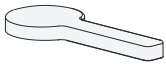

Accessori Accessories



cod. 411520404

TIEMME Raccorderie S.p.A.
Via Cavallera 6/A (Loc. Barco) - 25045 Castegnato (Bs) - Italy
Tel +39 030 2142211 R.A. - Fax +39 030 2142206
info@tiemme.com - www.tiemme.com

TIEMME Raccorderie S.p.A. si riserva di apportare modifiche in qualsiasi momento senza preavviso. È vietata qualsiasi forma di riproduzione, se non autorizzata.
TIEMME Raccorderie S.p.A. reserves the right to modify contents in any time without prior advise. Is forbidden any reproduction unless under TIEMME authorization